

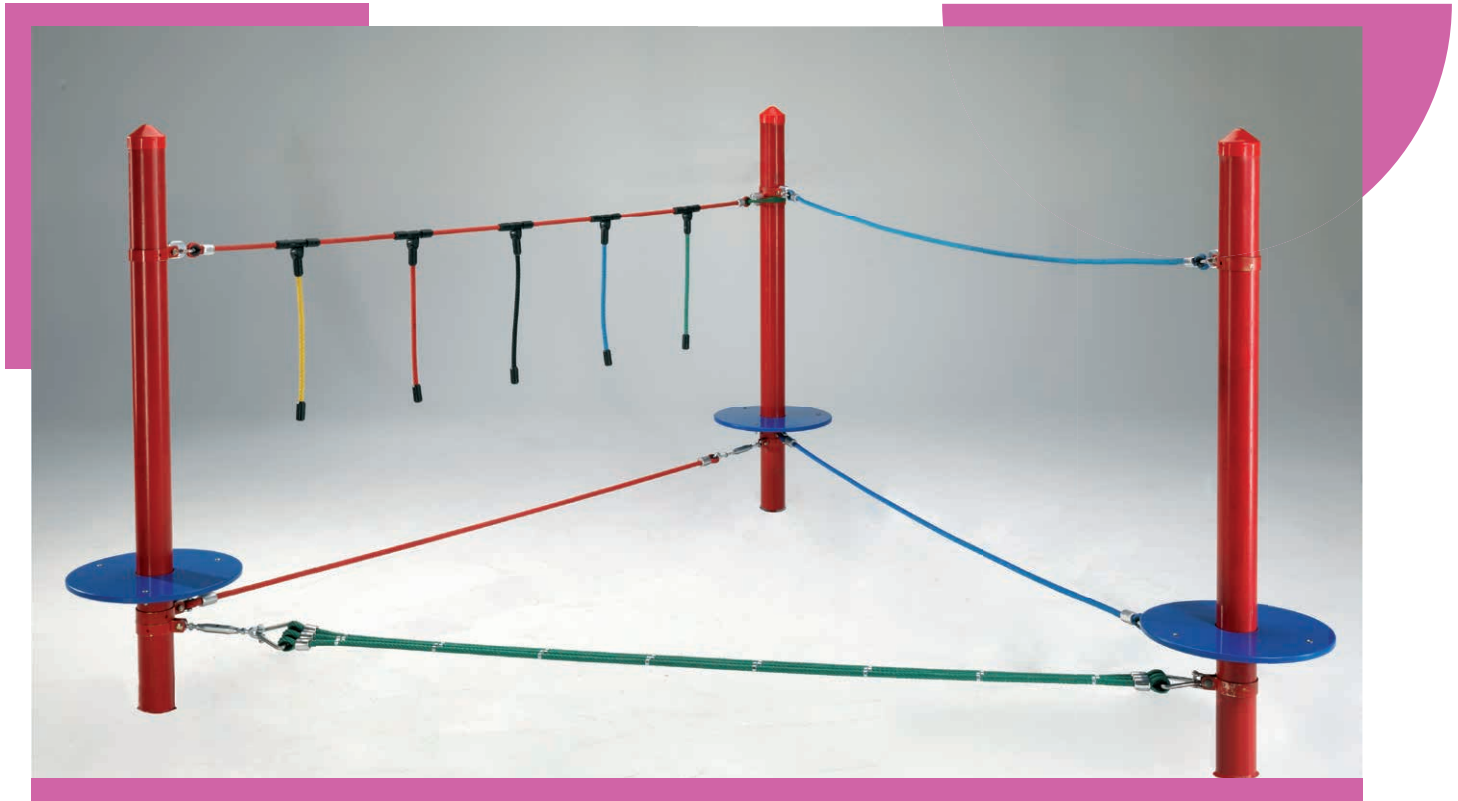









# La Slackline

Réf. 4591-70-K



-  1,65 m
-  3,50 x 3,10 m
-  29,50 m<sup>2</sup>
-  6,50 x 6,10 m
-  0,40 m
-  2,00 m<sup>3</sup>
-  15
- 

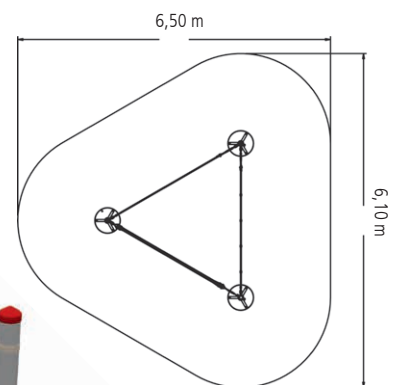
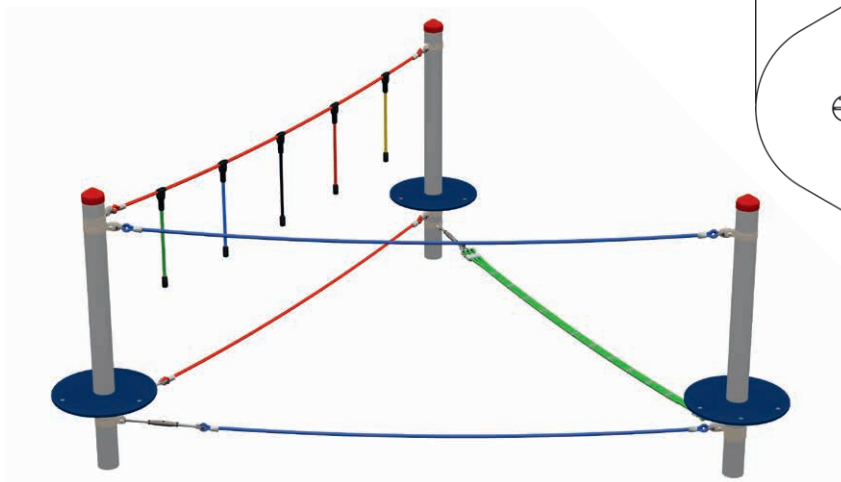

Composition :

3 poteaux en acier galvanisé à chaud (Ø 102 mm),  
longueur 2,40 m, avec repose-pieds Ø 500 mm  
Cordage Hercule Ø 16 mm

Eléments aussi disponibles séparément  
et dans d'autres longueurs (sur demande)

